

20FT X 20FT BACKLIT "CORNER" SEG TRADE SHOW DISPLAY

ASSEMBLY INSTRUCTION



Indoor Display
Solution



User
Friendly



Cutting-Edge
Design

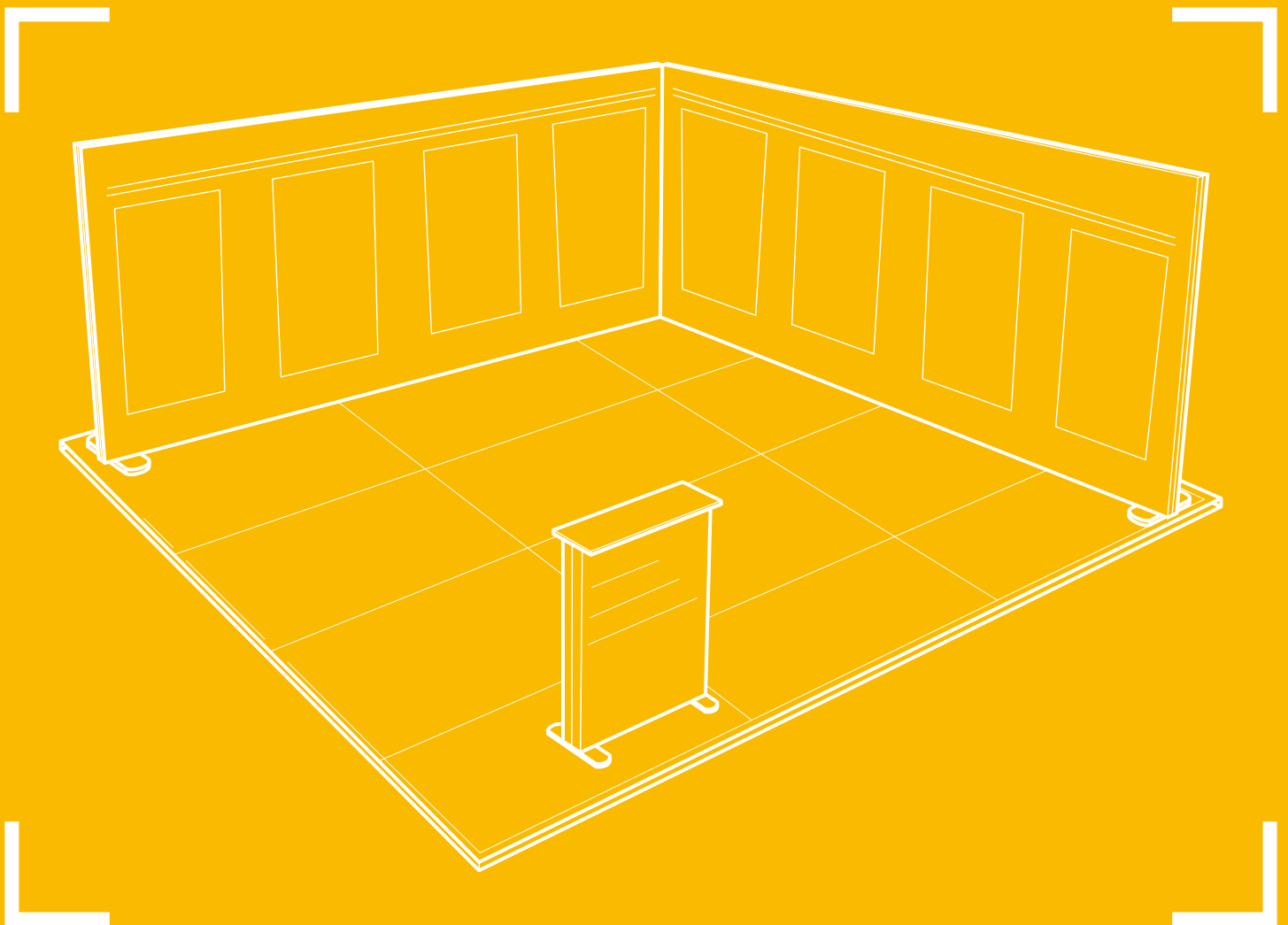

Components.

- 01 — Profile with LED Stripe
- 02 — Side Profile with Cable
- 03 — Side Profile without Cable
- 04 — Inner Strut

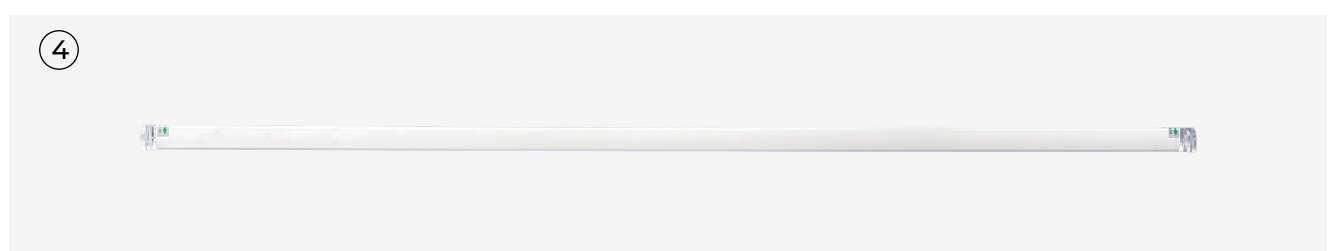
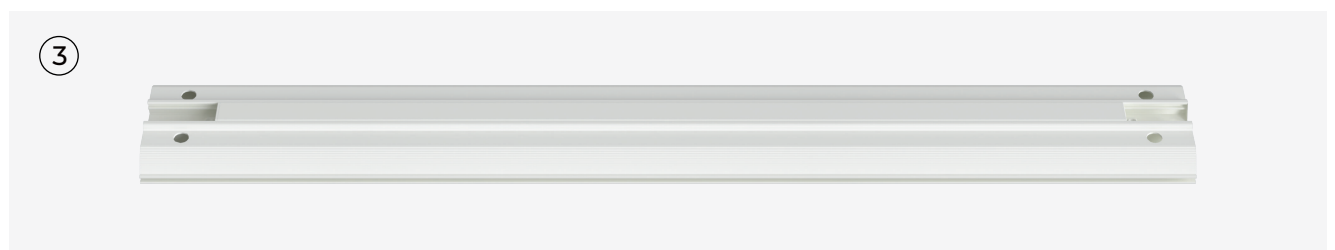
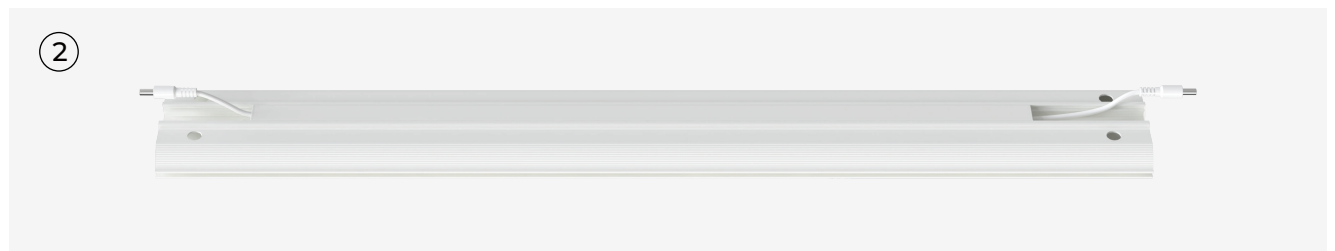

- 05** ——— Base Plate
- 06** ——— Bottom Connector
- 07** ——— Side Connector
- 08** ——— Corner Connector
- 09** ——— Middle Feet
- 10** ——— Middle Cross Connector
- 11** ——— Connecting Cable
- 12** ——— Power Supply with Device Plugin

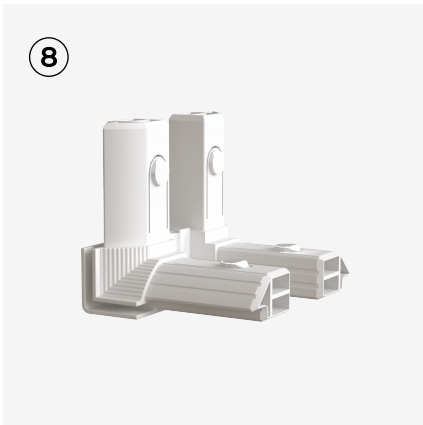

20ft SEG Backlit Backwall Assembly Instruction

Applies to: 20ft x 8.2ft

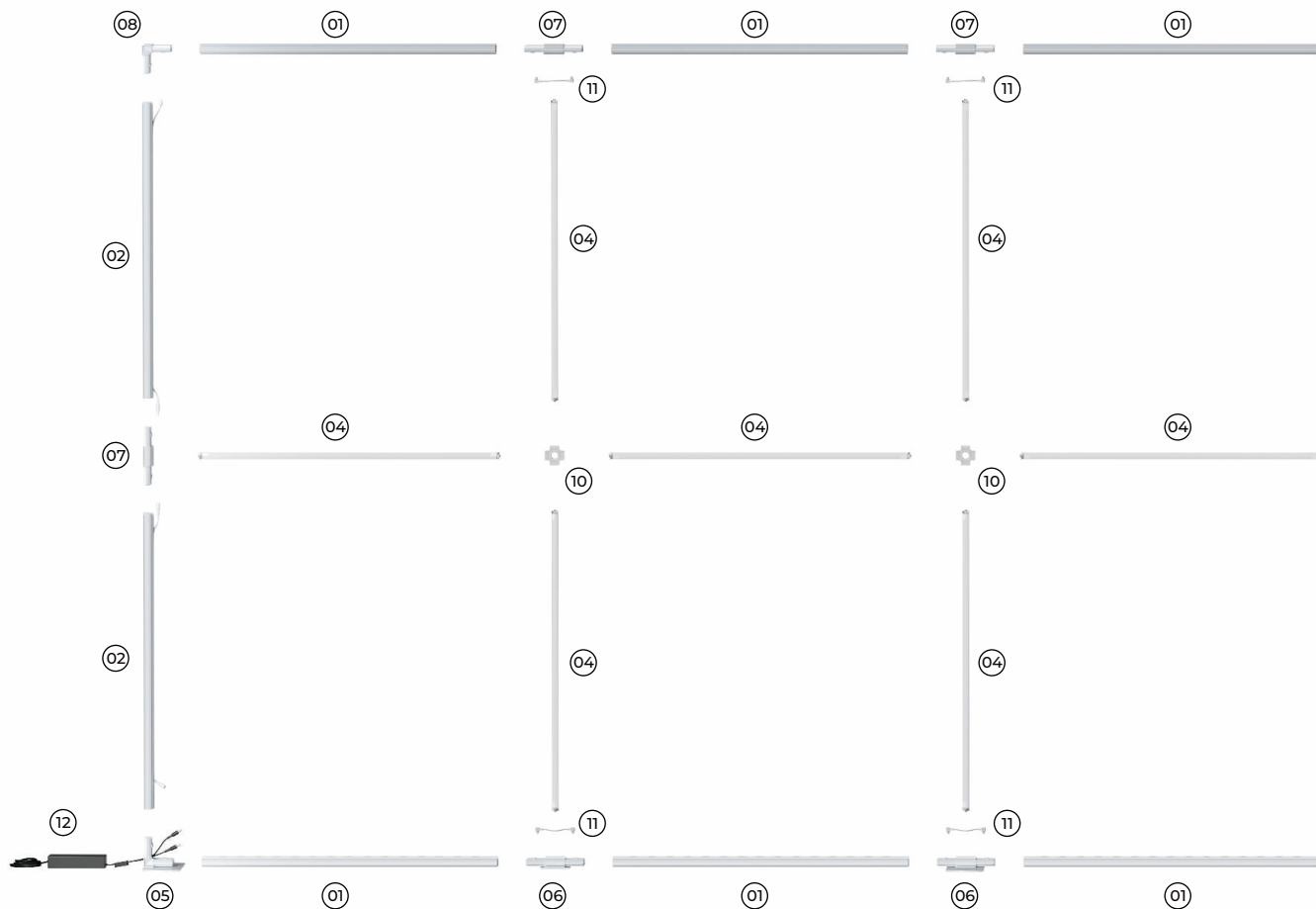

- 01** Profile with LED Stripe (x12)
- 02** Profile with Cable (x4)
- 03** Profile without Cable (x4)
- 04** Inner Strut (x16)

- 05** Base Plate (x2)
- 06** Bottom Connector (x3)
- 07** Side Connector (x7)
- 08** Corner Connector (x2)

- 10** Middle Cross Connector (x5)
- 11** Connecting Cable (x8)
- 12** Power Supply with Device Plugin (x2)

Storage & Care:

Store in a cool dry location. Clean hardware with a damp cloth. Machine wash the graphics in cold water on a gently cycle. Air dry only. Use a steamer for wrinkles. Never dry-clean.

20ft SEG Backlit Backwall Assembly Instruction

Applies to: 20ft x 8.2ft

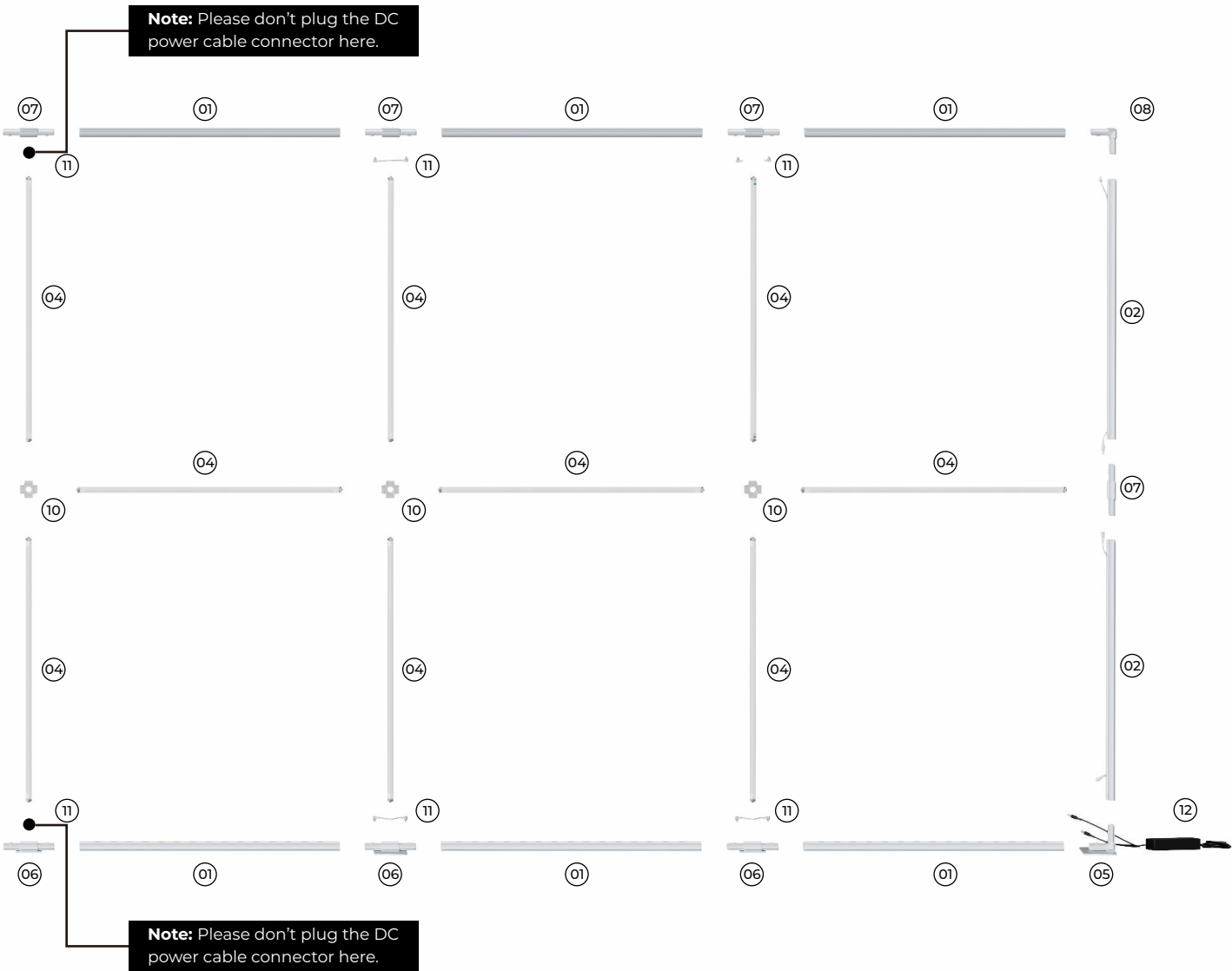

- | | | |
|---|---------------------------------|--|
| 01 Profile with LED Stripe (x12) | 05 Base Plate (x2) | 10 Middle Cross Connector (x5) |
| 02 Profile with Cable (x4) | 06 Bottom Connector (x3) | 11 Connecting Cable (x8) |
| 03 Profile without Cable (x4) | 07 Side Connector (x7) | 12 Power Supply with Device Plugin (x2) |
| 04 Inner Strut (x16) | 08 Corner Connector (x2) | |

Storage & Care:

Store in a cool dry location. Clean hardware with a damp cloth. Machine wash the graphics in cold water on a gently cycle. Air dry only. Use a steamer for wrinkles. Never dry-clean.

10ft SEG Backlit Counter Assembly Instruction

Applies to: 3.3ft x 3.3ft



01 Profile with LED Stripe (x2)

02 Profile with Cable (x2)

03 Profile without Cable (x2)

05 Base Plate (x2)

08 Corner Connector (x2)

12 Power Supply with Device Plugin (x1)

13 Tabletop Panel with LED Stripes (x1)

Storage & Care:

Store in a cool dry location. Clean hardware with a damp cloth. Machine wash the graphics in cold water on a gently cycle. Air dry only. Use a steamer for wrinkles. Never dry-clean.